

Welcome to Devialet!

You are now the owner of the world's most high performance audio system.

Protected by 68 patents, it integrates hybrid analogue - digital ADH® amplification and SAM® signal processing technologies. You are about to experience and share moments of extraordinary emotion. And this is just the beginning! Regular updates that are downloadable free of charge from our web site ensure that your audio system will be even better going forward.

This guide presents your product's basic installation steps. For any other assistance, please don't hesitate to contact us via help.devialet.com.

To go further, register on www.devialet.com to download the latest updates and to program advanced configurations.

The Devialet team

Set-up guide

1	BOX CONTENTS	p. 3
2	REGISTRATION	p. 4
3	FIRST CONFIGURATION	p. 5
4	FIRST USE	p. 10
5	THE REMOTE CONTROL	p. 11
6	CREATE A NEW CONFIGURATION	p. 12
7	SOFTWARE UPDATES	p. 14
8	VERTICAL INSTALLATION	p. 16

1 BOX CONTENTS

- 1 Devialet
- 1 Remote control with integrated batteries (AAA LR03 1.5V)
- 1 Power cable
- 1 SD card
- 1 User manual
- 1 Warranty booklet
- 1 Microfibre cloth
- 1 Pair of gloves

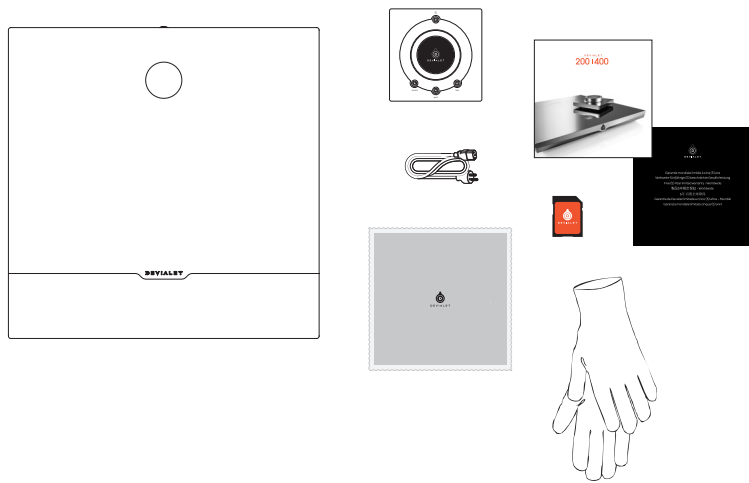

2 REGISTRATION

Prior to turning on your Devialet, it is essential to register it on our web site.

To do so, provide the serial number of your Devialet, indicated on the back of this manual, and go to your personal space at www.devialet.com/login.

Registering your Devialet will give you access to:

- a 3-year warranty extension;
- online configuration tools to configure your Devialet in minute detail;
- software updates to benefit from improvements to performance and new features;
- online customer support to answer any of your questions.



3 FIRST CONFIGURATION

Just like your computer or cellular phone, your Devialet is controlled by internal software. This software enables you to update and configure your Devialet, and in particular, to:

- activate SAM® technology to adapt your Devialet's output signal to your speakers;
- activate, disable and configure your Devialet's inputs and outputs (pre-out, Wi-Fi, advanced Phono stage);
- activate, disable and configure the main features, including the safety settings (power, standby mode, etc.).

To configure your Devialet, you will need a computer connected to the Internet and the SD card provided.

CONFIGURATOR AND SD CARD

The configurator is the online tool on devialet.com that enables you to configure your Devialet.

This configurator create a file that is saved on the SD card.

The SD card enables you to transfer your configuration file - downloaded from the configurator - from your computer to your Devialet.

After you have registered your Devialet (see page 4), insert the SD card in your computer SD card reader, go to the configurator on devialet.com, and follow the instructions.

Please note that all of your configurations may be named and are saved on your personal space on **devialet.com**.









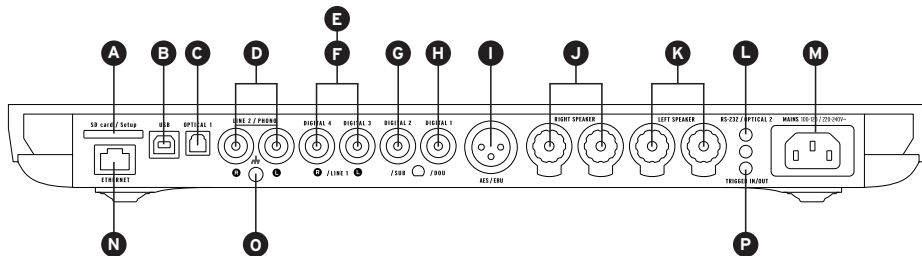

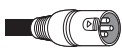

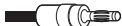

Please note: Your Devialet already has a default configuration: for a quick start, go directly to page 10 (First use).



CONFIGURATION OF THE CONNECTORS

The Devialet has a large number of inputs in order to offer you a wide range of possible usages. By default, these inputs are all active. Once on the configurator, click on each of the connectors to configure them to your liking using the diagram below.



A		SD CARD / SET-UP SD CARD SLOT FOR CONFIGURATION OF THE AMPLIFIER AND UPDATES	I		AES/EBU XLR DIGITAL INPUT FOR PROFESSIONAL SOURCES
B		USB PORT FOR COMPUTER CONNECTION	J K		RIGHT SPEAKER & LEFT SPEAKER UNIVERSAL SPEAKER CONNECTORS (BANANA PLUGS OR SPADES)
C		OPTICAL 1 OPTICAL INPUT FOR CD PLAYER, DVD PLAYER, IPOD, APPLE® AIRPORT STATION, COMPUTER, BLU-RAY, MODEM, ETC .	L		RS-232 / OPTICAL 2 PORT FOR HOME AUTOMATION APPLICATIONS AND OPTICAL INPUT (3.5MM JACK)
D		PHONO 2 (MM/MC) / LINE 2 ADVANCED PHONO STAGE FOR A VINYL TURNTABLE OR TUNER LINE INPUT	M		MAINS 100-120/220-240V POWER SUPPLY (EARTH WIRE REQUIRED)
E		PHONO 1 (MM/MC) / LINE 1 / DIGITAL3/4 * ADVANCED PHONO STAGE FOR A VINYL TURNTABLE OR TUNER LINE INPUT OR S/ PDIF (COAXIAL) DIGITAL INPUTS FOR CD PLAYER, DVD PLAYER, TV...	N		ETHERNET RJ45 SOCKET FOR NETWORK
F		PHONO 1 (MM/MC) / LINE 1 / DIGITAL3/4 * ADVANCED PHONO STAGE FOR A VINYL TURNTABLE OR TUNER LINE INPUT OR S/ PDIF (COAXIAL) DIGITAL INPUTS FOR CD PLAYER, DVD PLAYER, TV...	O		GROUNDING FOR TURNTABLE TONEARM
G		DIGITAL 2 * S/PDIF (COAXIAL) DIGITAL INPUT FOR CD PLAYER, DVD PLAYER, TV...	P		TRIGGER IN/OUT FOR CONNECTING HIFI COMPONENTS (3.5MM JACK)
H		DIGITAL 1 * S/PDIF (COAXIAL) DIGITAL INPUT FOR CD PLAYER, DVD PLAYER, TV...			

*Configurable connectors for digital inputs, analogue inputs or mono/stereo analogue outputs.



SAM® (SPEAKER ACTIVE MATCHING) CONFIGURATION

Exclusive SAM® technology enables you to adapt the signal sent by your Devialet to your speakers. To activate it, go to the online configurator and select your speakers from the available list.

STREAMER CONFIGURATION & DEVIALET AIR

Devialet's built-in streamer and Devialet AIR technology enable you to send all your music in high definition from your computer to your Devialet.

To stream your music, your Devialet must be connected to the same network as your computer, either in wired or wireless mode.

Wired mode

To use the wired mode, simply connect your Devialet to your network by using the Ethernet input in back of your device (see pages 6 et 7, «Connectors»).

Wireless mode

To use the wireless mode (Wi-Fi), go to the online configurator and provide the name of your Wi-Fi network and its associated password or key.

Make sure that your Devialet is installed in an environment where network reception is good.

Next, download the Devialet AIR application from your Devialet personal space and save it on your computer.

You can now use all your content.

DUAL-MONO CONFIGURATION

The Dual-mono feature is used to devote all of a Devialet's capacities to a single speaker and to radically increase your system's performance.

This function requires two Devialet units and a configuration of each device via the Configurator.

In this configuration, one device is called the Master device. This is the Devialet that receives the signals from the remote control. The Companion device receives information from the Master device.

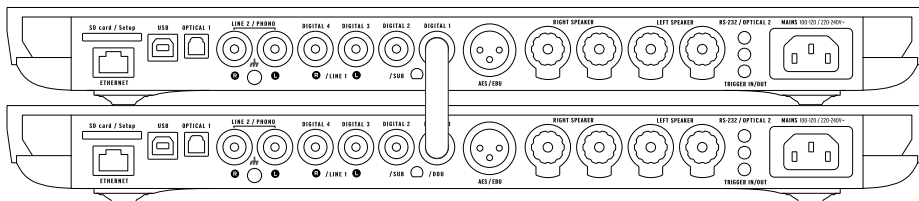

To configure your system in dual-mono mode, connect each speaker to a device and connect them using a digital cable (S/PDIF or S/PDIF-AES/EBU).

If you wish to use your companion device's inputs, connect both devices using a stereo mini-jack analogue cable.

Other configurations are also possible via the configurator (multi-amplification, multi-room, etc.).

They will enable you to meet all your expectations and to significantly boost your system's performance.

4 FIRST USE

After having registered (see page 4) and configured (see pages 5 to 9) your Devialet, remove the device from its box. Carefully remove the plastic protection, remove the protective hood by horizontally pulling on it in order to access the connectors and insert the SD card in back of the Devialet.

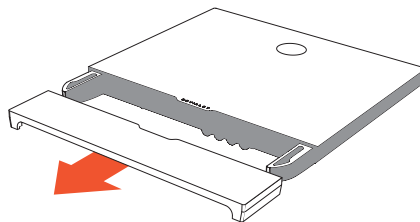

Connect your sources (CD player, vinyl turntable, Blu-ray player, television, etc.) to the previously configured inputs. Proceed to the connection of your speakers by connecting them to the corresponding inputs (J and K), making sure to observe the correct polarity. The speakers must be placed equidistant from the listener for best performance.

Next, connect your Devialet to a mains outlet using the power cord provided in the box. It is essential that the outlet be grounded.

Turn on the Devialet by pressing the power button on the remote control.

The device automatically detects your personal configuration. When the Devialet's screen displays the volume, select the desired source using the remote control (source button).

Start playing music!

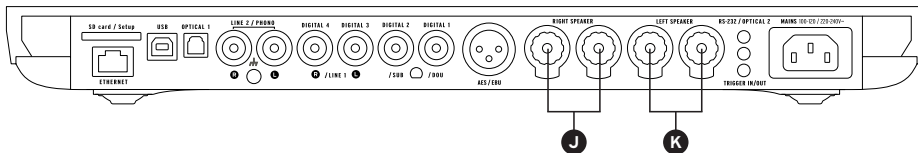

5 REMOTE CONTROL

The remote control allows you to control the Devialet and access the various menus, which are displayed on the device's control screen.

The Devialet's remote control operates via radio waves: there is no need to point it in the direction of the device.

In the event of connection loss between the remote control and your Devialet, bring the remote closer to your device and press the volume button until both devices are automatically recognised.

The battery compartment is located at the back of the remote control.
Battery life is over 2 years.

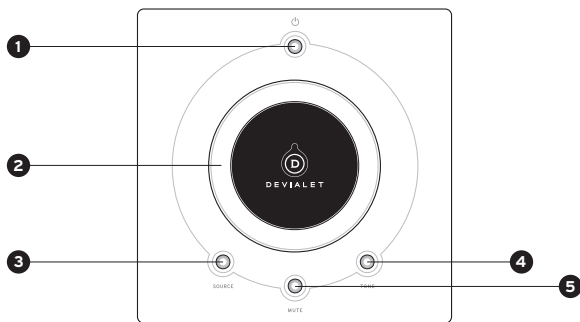

1 POWER

- Short press: standby, ON
- Long press: OFF

2 VOLUME CONTROL AND MENU NAVIGATION

3 SOURCE

- Short press: change source
- Long press: sampling frequency

4 TONE

- Short press: balance/bass/treble
- Long press: Menu
- To navigate within the menu, use short presses. A long press exits the menu.

5 MUTE

- Short press: Devialet silent mode

6 CREATE A NEW CONFIGURATION

You may change the configuration of your Devialet as many times as you wish, while saving your previous configurations in your personal space.

To create a new configuration:

1 - Remove the SD card from the back of the device, beneath the cover.

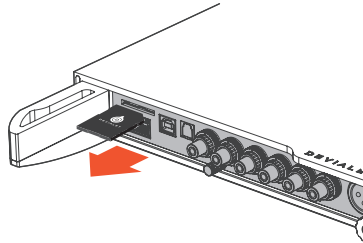

2 - Insert it into your computer's SD card reader. Go to www.devialet.com and follow the instructions in the section entitled Configurator.



3 - Once your configuration has been saved to the SD card, reinsert it into the card reader of your Devialet.

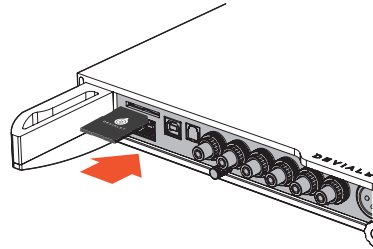

4 - The new configuration will be read automatically by your Devialet on insertion of the SD card. There is no need to restart the device.

Leave the card in the card reader.
If you wish to restore the default configuration, simply remove the SD card and restart.

You may use multiple SD cards if you wish to quickly change from one configuration to another.



7 SOFTWARE-UPDATES

The updates provided by Devialet continually improve the performance, functions and usability of its products.

These new updates are free and directly available from www.devialet.com within your personal space.

1 - Turn off your Devialet and remove the SD card (located at the back of the device).

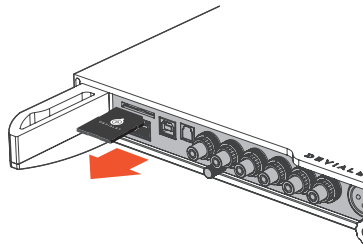

2 - Once the update file has been downloaded from the www.devialet.com website and saved to your SD card, reinsert the card in the card reader of your Devialet (without write protection).

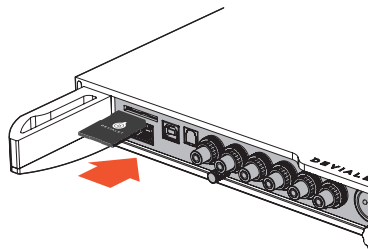

3 - Restart your Devialet by pressing and holding the power button for approximately 4 seconds. Until the word «reset» appears. The control screen will display the loading progress of the update. This may take several minutes. Once the process is finished, follow the instructions displayed on the control screen. Your Devialet is now up-to-date.

After updating, you can delete the files on the SD card, if you wish to use it for a new configuration.



8 VERTICAL INSTALLATION

To vertically install your Devialet, use the wall mount available from your Devialet retailer. The control screen will automatically rotate according to the chosen position. An installation guide is provided with the wall mount.

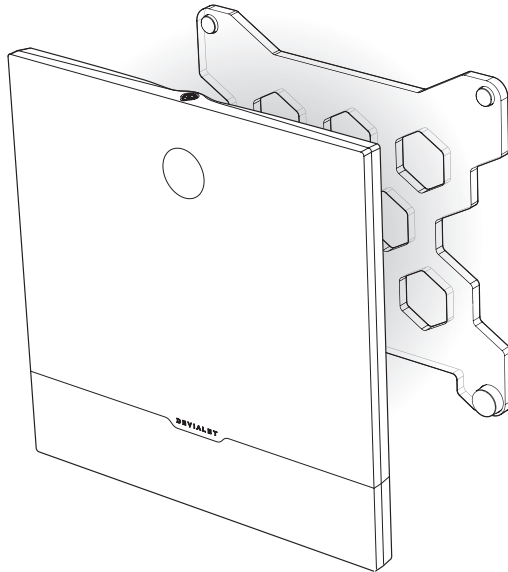

MAINTENANCE AND PRECAUTIONS

Clean the Devialet and the remote control with the microfibre cloth provided. Do not use tissues or paper towels.

Never cover your Devialet during operation, as the heat must be allowed to escape.

The Devialet delivers music with an extreme linearity without distorting the sound, even at high volume. It can thus be tempting to listen at high levels. take care of your ears by limiting the volume when listening for prolonged periods.

TECHNICAL SUPPORT

E-Mail
support@devialet.com

Devialet Support
help.devialet.com

